

Type: 1140-G.5



Miniaturised double pole thermal circuit breaker with push-to-reset tease-free, trip-free, snap action mechanism (R-type TO CBE to EN 60934). Threadneck panel mounting. Suitable for line and neutral switching - the thermal actuator operating on one pole simultaneously opens both poles under overload conditions. Approved to CBE standard EN 60934 (IEC 60934).

Voltage rating:

- AC 240 V
- DC 48 V
- UL/CSA: AC 250 V
- UL/CSA: DC 50 V

Current ratings:

from 0.05 A to 16 A

Number of poles:

double pole

Mounting method:

threadneck

Terminal design:

blade terminals

Actuation:

push button

Auxiliary contacts:

without auxiliary contacts

Water splash protection:

with water splash protection
without water splash protection

Illumination:

without illumination

Typical life:

- 0.05...3 A: 3,000 operations at $2 \times I_N$, resistive
- 3.5...8 A: 1,000 operations at $2 \times I_N$, resistive
- 10...16 A: 100 operations at $2 \times I_N$, inductive

Interrupting capacity I_{cn} :

- 0.05...3 A: $6 \times I_N$
- 3.5...8 A: $8 \times I_N$
- 10...16 A: 120 A

Approvals:

VDE, CSA, UL, Kema

Dimensions

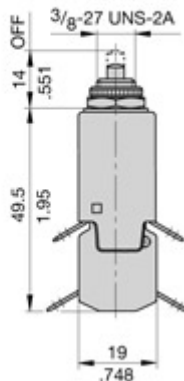

Internal connection diagrams

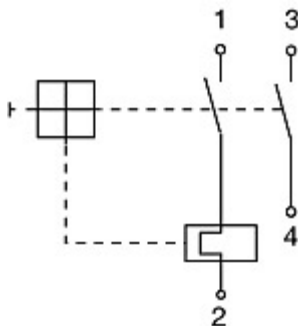

Description

Miniaturised double pole thermal circuit breaker with push-to-reset tease-free, trip-free, snap action mechanism (R-type TO CBE to EN 60934). Threadneck panel mounting. Suitable for line and neutral switching - the thermal actuator operating on one pole simultaneously opens both poles under overload conditions. Approved to CBE standard EN 60934 (IEC 60934).

Typical applications

Motors, transformers, solenoids, hand-held machines and appliances. Especially suited to AC duties where the correct orientation of line/neutral is not known/cannot be guaranteed.

Ordering information

Type No.	Description
1140	double pole threadneck panel mounting
Mounting	
G1	threadneck panel mounting 3/8-27UNS, with hex nut and knurled nut*
G4	threadneck panel mounting 3/8-27UNS, with knurled nut*
Number of poles	
5	double pole, 1-pole protected
Actuator style	
1	black push button (standard)
Terminal design	
P7	blade terminals DIN 46244-C (QC 2x.110)
Characteristic curve	
M1	medium delay
Current ratings	
0,05...16 A	
1140 - G1 5 1 - P7 M1 - 16 A ordering example	

*mounting hardware bulk shipped

Standard current ratings and typical internal resistance values

Current rating (A)	Internal resistance (Ω)	Current rating (A)	Internal resistance (Ω)
0.05	345	1.8	0.3
0.06	240	2	0.3
0.08	142	2.5	0.2
0.1	88	3	0.1
0.2	24	3.5	0.08
0.3	9.9	4	0.07
0.4	5.9	5	0.05
0.5	3.7	6	0.04
0.6	2.2	7	< 0.02
0.7	1.9	8	< 0.02
0.8	1.4	10	< 0.02
1	0.9	12	< 0.02
1.2	0.6	15	< 0.02
1.5	0.5	16	< 0.02

Approvals

Authority	Voltage ratings	Current ratings
VDE	AC 240 V; DC 48 V	0.05...16 A
CSA, UL	AC 250 V; DC 50 V	0.05...16 A
Kema (EN 60934)	AC 240 V; DC 48 V	0.05...16 A



Technical data

For further details please see chapter: **Technical Information**

Voltage rating	AC 240 V; DC 48 V (UL: AC 250 V; DC 50 V)	
Current ratings	0.05...16 A	
Typical life	AC + DC	
	0.05...3 A	300 operations at 2 x I _N , inductive 3,000 operations at 2 x I _N , resistive
	3.5...8 A	200 operations at 2 x I _N , inductive 1,000 operations at 2 x I _N , resistive
	9...16 A	100 operations at 2 x I _N , inductive
Ambient temperature	-20...+60 °C (-4...+140 °F) T 60	
Insulation co-ordination (IEC 60664 and 60664A)	rated impulse withstand voltage 2.5 kV reinforced insulation in operating area	pollution degree 2
Dielectric strength (IEC 60664 and 60664A)	test voltage operating area pole/pole	AC 3,000 V AC 1,500 V
Insulation resistance	> 100 MΩ (DC 500 V)	
Interrupting capacity I _{cn}	0.05...3 A 3.5...8 A 10...16 A	6 x I _N 8 x I _N 120 A
Interrupting capacity (UL 1077)	I _N 0.05...16 A 0.05...7 A 8...16 A	U _N DC 50 V AC 250 V AC 250 V
		200 A 1,000 A 2,000 A
Degree of protection (IEC 60529/DIN 40 050)	operating area IP40 terminal area IP00	
Vibration	10 g (57-500 Hz) ± 0.76 mm (10-57 Hz), to IEC 60068-2-6, test Fc, 10 frequency cycles/axis	
Shock	25 g (11 ms) to IEC 60068-2-27, test Ea	
Corrosion	96 hours at 5 % salt mist, to IEC 60068-2-11, test Ka	
Humidity	240 hours at 95 % RH to IEC 60068-2-3, test Ca	
Mass	approx. 13 g	

Dimensions

1140-G15...

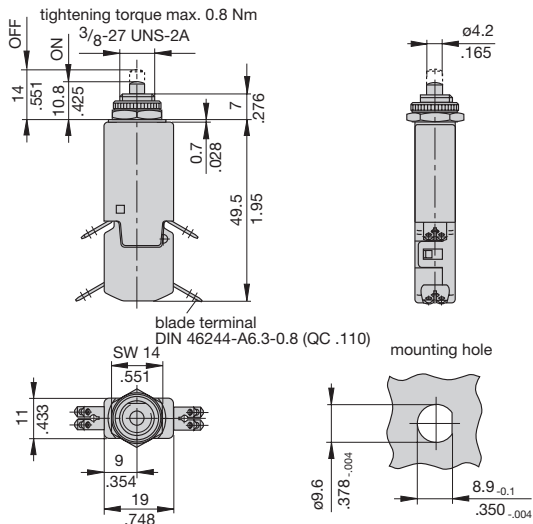

Internal connection diagram

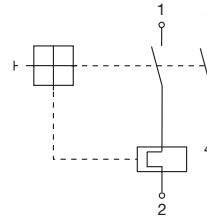

Typical time/current characteristics at +23 °C/+73.4 °F

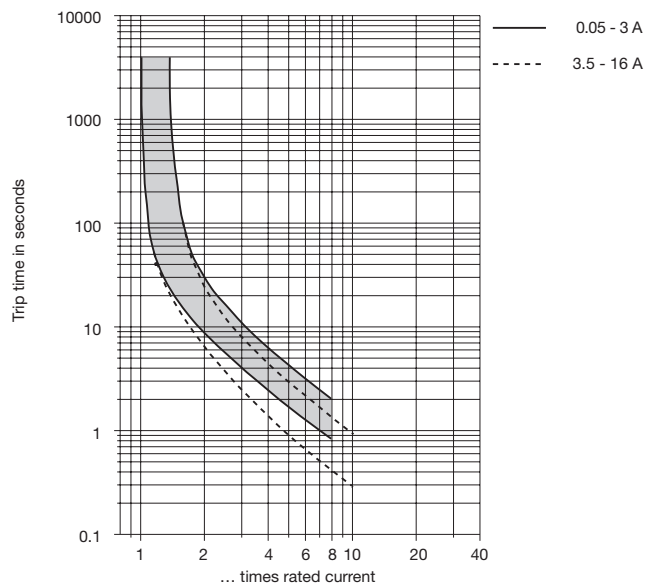

The time/current characteristic curve depends on the ambient temperature prevailing. In order to eliminate nuisance tripping, please multiply the circuit breaker current ratings by the derating factor shown below. See also section 9 – Technical information.

Ambient temperature °F	-4	+14	+32	+73.4	+104	+122	+140
°C	-20	-10	0	+23	+40	+50	+60
Derating factor	0.76	0.84	0.92	1	1.08	1.16	1.24

Installation drawing

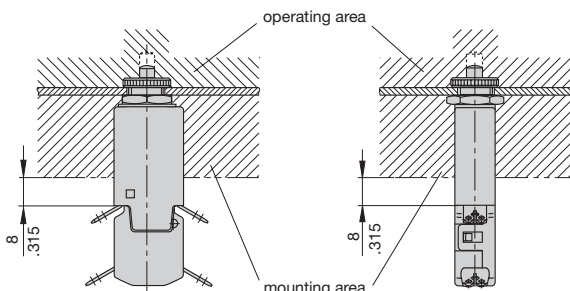

Accessories

Water splash cover/knurled nut assembly, transparent X 201 285 01 (IP64)

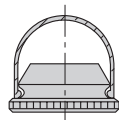

This is a metric design and millimeter dimensions take precedence ($\frac{\text{mm}}{\text{inch}}$)

All dimensions without tolerances are for reference only. In the interest of improved design, performance and cost effectiveness the right to make changes in these specifications without notice is reserved. Product markings may not be exactly as the ordering codes. Errors and omissions excepted.